



flowcon[®]

VSD - G Inverter

OPERATION AND MAINTENANCE MANUAL

First Publication Date: 01/09/2020

Revision:

Revision Date:

OPERATION & MAINTENANCE

CONTENTS

General Information	3
Safety Information	4
Safety Warnings & Precautions	5
Customer / Contractor Responsibilities	6
Protection of the environment	7
Sites exposed to ionizing radiations	7
Transportation and Storage	7
Unit handling	7
Storage	8
Technical Description	8
Motor data plate	9
Motor type definition code	9
Pump Data Plate	10
Design and layout	10
Mechanical installation	12
Operation	19
Control panel	20
LEDs description	21
Parameters menu visualization	23
Technical references	30
Troubleshooting	32
Alarm codes	33
Error codes	34
Technical Data	35
Dimensions and weights	36

General Information

These instructions are to assist in the installation of the flowcon VSD - G Inverter please follow them carefully.

If, having read this Operation & Maintenance Manual, there is any doubt about any aspect of the installation please don't hesitate to contact our technical team.

Definitions of Safety Warnings and Precautions



WARNING!

Indicates a potentially hazardous situation which, if not avoided, can result in serious injury or death.



CAUTION!

Indicates a potentially hazardous situation which, if not avoided. Can result in minor to moderate injury, or serious damage to the product.

Safety

Information

It is essential that correct and safe working practices are adhered to at all times when installing, operating and/or maintaining any piece of equipment. Always consult safety data sheets, operating and maintenance manuals, Health & Safety legislation and recommendations and specific requirements of any equipment manufacturer, site controller, building manager or any other persons or organisation relating to the procurement, installation, operation and/or maintenance of any piece of equipment associated or in conjunction with any product provided by **flowtech** Water Solutions.

This document is intended for ALL installers, operators, users and persons carrying out maintenance of this equipment and must be kept with the equipment, for the life of the equipment and made available to all persons at all times. Prior to carrying out any work associated with the set it is essential that the following sheets are read, fully understood and adhered to at all times.

Equipment must only be installed, operated, used, and/or maintained by a competent person. A competent person is someone who is technically competent and familiar with all safety practices and all of the hazards involved.

Any damage caused to any equipment by misapplication, mishandling or misuse could lead to risk of Electrocutation, Burns, Fire, Flooding, death or injury to people and/or damage to property dependent upon the circumstances involved. **flowtech** Water Solutions accepts no responsibility or liability for any damage, losses, injury, fatalities or consequences of any kind due to misapplication, mishandling or misuse of any equipment, or as a result of failure to comply with this manual.

Failure to install, operate, use or maintain the equipment in accordance with the information contained within this document could cause damage to the equipment and any other equipment subsequently connected to it, invalidating any warranties provided by **flowtech** Water Solutions to the buyer.

Safety Warnings &

Precautions

These instructions should be read and clearly understood before working on the system. Please read this manual carefully and all of the warning signs attached before installing or operating the equipment keep this manual handy for your reference. This equipment should be installed, adjusted and serviced by trained and qualified personnel. Failure to observe this precaution could result in bodily injury.



WARNING! - Install an emergency stop key separately from the isolator. Rotating shafts can be hazardous.



WARNING! - This equipment has a high leakage current and must be permanently fixed to earth.



WARNING! - Do not attach or remove wiring or connectors when the power is applied. Do not check signals during operation. When the power is turned on and the running command is on, the motor will start rotating. The stop key is only effective when the function is set. If there is a power failure and an operation instruction is given the unit may start automatically when the power is reinstated.



WARNING! - Make sure that the input voltage is correct. Be sure to install the unit in a room that is not exposed to direct sunlight and is well ventilated.

Avoid environments which have a high ambient temperature, high humidity or excessive condensation. Avoid dust. Corrosive gas, explosive gas, inflammable gas, grinding-fluid mist and salt damage, etc.



WARNING! - Do not connect the power source to any terminals except power connectors.



WARNING! - Motor control equipment and electronic controllers are connected to hazardous line voltages. When servicing drives and electronic controllers, you may be exposed to components at or above the line potential. Extreme care should be taken to protect against shock. Dangerous voltage may exist after the power light is off.

Wait more than 5 minutes after turning off the power supply before performing maintenance or inspection. Hazard of electric shock. Disconnect incoming power before working on this unit.



WARNING! - The inverter should be protected separately against ground fault.

Observe the regional regulations for electrical installation!



CAUTION! - It is strongly recommended that all electrical equipment conforms to National Electrical Codes and local regulations. Only qualified personnel should perform installation, alignment and maintenance. The manufacturer reserves the right to alter the technical data in order to make improvements or update information.



CAUTION! - Failure to observe these rules will render the guarantee invalid. The same applies to repair jobs and/or replacement. Your legal rights are not affected.



CAUTION! - The manufacturer declines all responsibility in the event of damage or injury caused as a result of tampering with the equipment.



CAUTION! - Do not switch on/off power supply to run/stop the motor/system! Start the unit only by using run button or external run command.

Customer / Contractor **RESPONSIBILITIES**

It is the responsibility of the customer and/or the contractor:

- To ensure that anyone working on the equipment is wearing all necessary protective gear and/or clothing.
- Is aware of appropriate health & safety warnings.
- Has read the information in this section of the manual.

Protection of the environment

Disposal of packaging and product
Comply with the current regulations on sorted waste disposal.

Sites exposed to ionizing radiations

If the product has been exposed to ionizing radiations, implement the necessary safety measures for the protection of people. If the product needs to be despatched, inform the carrier and the recipient accordingly, so that appropriate safety measures can be put in place.

Spare parts

When contacting Flowtech to request technical information or spare parts, always indicate the product type and code.

Product warranty

For information on the warranty refer to the documentation of the sale contract.

Transportation and Storage

Packaging inspection

1. Check that quantity, descriptions and product codes match the order.
2. Check the packaging for any damage or missing components.
3. In case of immediately detectable damage or missing parts:
 - Accept the goods with reserve, indicating any findings on the transport document, or
 - Reject the goods, indicating the reason on the transport document.
 - In both cases, promptly contact Flowtech from whom the product was purchased.

Unpacking and inspection of the unit

1. Remove packing materials from the product.
2. Release the product by removing the screws and/or cutting the straps, if fitted.

CAUTION: Cut and abrasion hazard
Always wear personal protective equipment.

3. Check the product for integrity and to make sure that there are no missing components.
4. In case of damage or missing components, promptly contact Flowtech.

Unit handling

The unit must be harnessed and lifted as shown in Figure 1.

- The product and its components may be heavy: risk of crushing
- Always wear personal protective equipment
- Manual handling of the product and its components must be in compliance with the current regulations on “manual load handling”, to avoid unfavourable ergonomic conditions causing risks of back-spine injury.
- Use cranes, ropes, lifting straps, hooks and clasps that comply with current regulations and that are suitable for the specific use
- Make sure that the harnessing does not damage the unit
- During the lifting operations, always avoid sudden movements that could compromise the stability of the load
- During handling, make sure to avoid injury to people and animals, and/or damage to property.

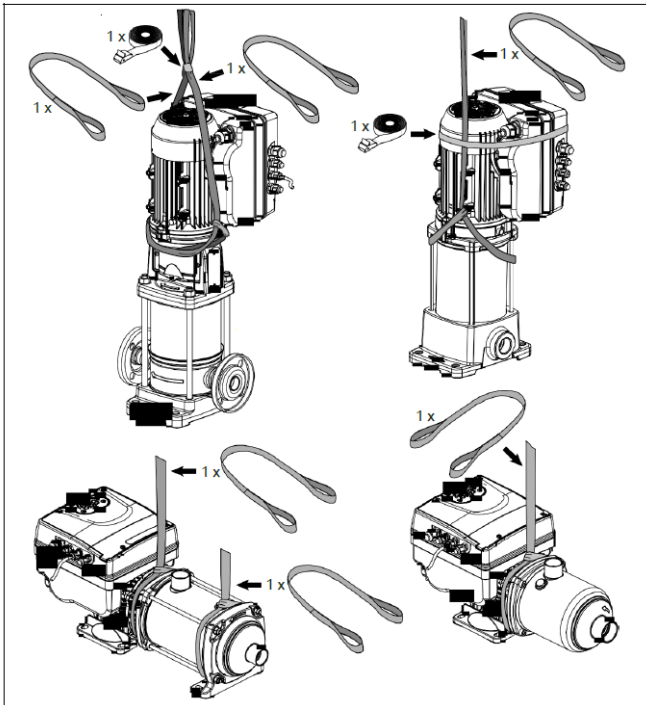

Figure 1: Lifting

Storage

The product must be stored:

- In a covered and dry place
- Away from heat sources
- Protected from dirt
- Protected from vibrations
- At an ambient temperature between -25°C and +65°C (-13°F and 149°F), and relative humidity between 5% and 95%.
- Do not place heavy loads on top of the product
- Protect the product from collisions.

Technical Description

Designation

Variable speed pump unit, vertical/horizontal, multi-stage, non self-priming.

Data plates

The data plate is a label showing:

- The main product details
- The identification code

Approval and certifications

For the approvals see the motor data plate:

Motor data plate

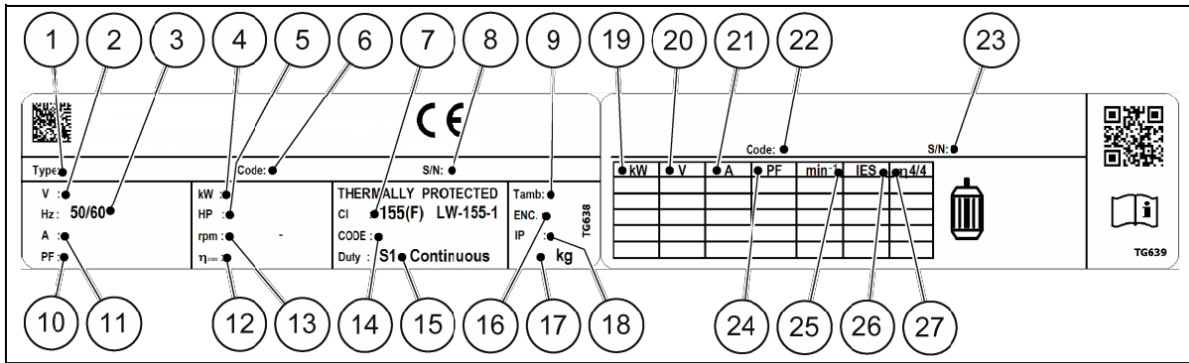
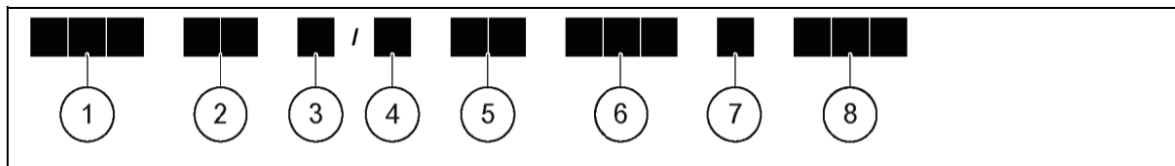

Figure 2: Motor data plate

1. Type definition code	15. Duty type
2. Rated voltage	16. Enclosure type (NEMA)
3. Rated frequency	17. Weight
4. Rated power [kW]	18. Protection class
5. Rated power [HP]	19. Shaft power
6. Part number	20. Voltage
7. Insulation class	21. Current
8. Serial number	22. Part number
9. Maximum ambient temperature	23. Serial number
10. Power factor	24. Power factor
11. Rated current	25. Speed
12. Motor drive efficiency	26. Power drive system efficiency class (to EN 50598-2)
13. Full power speed range	27. Full load efficiency
14. Code letter for locked rotor	

Motor type definition code



- 1. Series
- 2. Motor frame dimension 90R: Oversized Flange
80: Standard Flange
- 3. Shaft extension
□□: Standard shaft extension
S8: Custom Shaft extension
- 4. Power supply
1: single phase power supply
3: three phase power supply
- 5. Shaft power*10 [kW]
03: 0.37kW (0.50HP)
05: 0.55 kW (0.75 HP)
07: 0.75 kW (1.00 HP)
11: 1.10 kW (1.50 HP)
15: 1.50 kW (2.00 HP)
22: 2.20 kW (3.00 HP)
- 6. Motor frame arrangement
SVE: Flange with tapped holes and shaft w/o keyseat
B14: Flange with tapped holes
B5: Flange with free holes
HMHA: Suitable for 1-5 HM monolithic pumps
HMHB: Suitable for 1-5 HM pumps w/sleeve
HMVB: Suitable for 1-5 VM pumps

HMHC: Suitable for 10-22 HM pumps
 HMVC: Suitable for 10-22 VM pumps
 LNEE: Suitable for In-Line pumps
 56J: Compliant to NEMA 56 Jet standard
 56C: Compliant to NEMA 56C standard
 : Standard
 EU: EMEA
 208-240 : 208-240VAC 50/60Hz
 380-460 : 380-460VAC 50/60Hz
 230/400: 208-240/380-460VAC 50/60Hz

7. Reference market

8. Voltage

Pump Data Plate

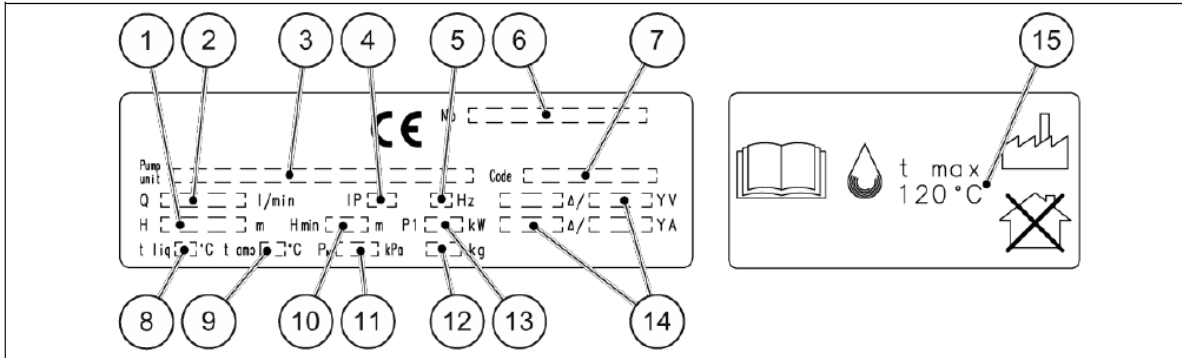

Figure 4: data plate

1. Head range	9. Maximum operating ambient temperature
2. Flow range	10. Minimum head (EN 60335-2-41)
3. Pump/electric pump unit type definition code	11. Maximum operating pressure
4. Protection class	12. Electric pump unit weight
5. Frequency	13. Electric pump unit absorbed power
6. Serial number (date + progressive number)	14. Electrical data
7. Electric pump unit/pump part number	15. Maximum operating liquid temperature (uses other than as EN 60335-2-41)
8. Maximum operating liquid temperature (uses as EN60335-2-41)	

Design and layout

The unit can be fitted with the features the application requires

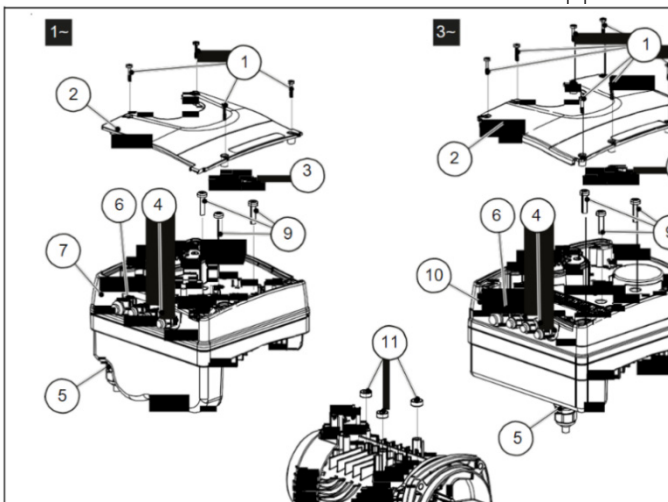

Figure 9: Main components - Single-phase and three-phase models

Table 1: Description of components

Position number	Description	Tightening torque $\pm 15\%$	
		[Nm]	[in•lbs]
1	Screw	1.4	12.4
2	Terminal Box Cover	-	-
3	Optional module with strip	-	-
4	M12 I/O cable gland	2.0	17.7
5	M20 cable gland for power supply cables	2.7	23.9
6	M16 I/O cable gland	2.8	24.8
7	Drive (single-phase model)	-	-
8	Motor	-	-
9	Screw	6.0	53.1
10	Drive (three-phase model)	-	-
11	Spacer	-	-

Pre-assembled ex factory components

Table 2: Included components

Component	Quantity	Notes	
Plug for Cable Gland	M12	3	
	M16	1	
	M20	1	
Cable gland and lock nut	M12	3	Cable Outer Diameter:
	M16	1	
Cable Gland	M20	1	4.5 to 10.0 mm (0.177-0.394 in)
			7.0 to 13.0 mm (0.275-0.512 in)

Optional components

Table 3: Optional components

Component	Description
Sensors	The following sensors can be used with the unit: Level-sensor
RS485 Module	For the connection of a multi-pump system to a supervision system, via cable (Modbus or BACnet MS/TP protocol)
Wireless Module	To connect and interact wireless with e-SM Drive
Adaptor	M20 Metric to 1/2" NPT Adapter

The product can be used to pump:

- cold water
- Hot water

The variable speed pump units are made for the following applications:

- Pressure, level, and flow regulation (open loop systems)
- Single or multi pump irrigation systems.

Actuator (constant speed)

The unit operates as an actuator according to speed set point; this is done through user interface, the corresponding analog input or the communication bus.

Controller (constant pressure)

This mode is set as the default operating mode, and is used for single pump operating units.

Cascade serial / Cascade synchronous

The units are connected via the RS485 interface and communicate via the provided protocol. The

combination of the different units which are used in a multi-pump system depends on the system requirements.

It is possible to run all pumps in cascade serial mode and cascade synchronous mode as well. If one unit fails, then each pump of the system can become the lead pump and can take control.

Improper use

The product must not be used for closed loop systems.

Mechanical installation

Installation area

Potentially explosive atmosphere hazard

The operation of the unit in environments with potentially explosive atmospheres or with combustible dusts (e.g.: wood dust, flour, sugars and grains) is strictly forbidden.

WARNING:

Always wear personal protective equipment

Always use suitable working tools

When selecting the place of installation and connecting the unit to the hydraulic and electric power supplies, strictly comply with current regulations.

Ensure that the input protection rating of the unit (IP 55, NEMA Type 1) is suitable for the installation environment.

CAUTION:

Input protection: to ensure the IP55 (NEMA type 1) protection index make sure that the unit is closed correctly.

Before opening the terminal box cover, make sure that there is no water in the unit

Make sure that all unused cable glands and cable holes are correctly sealed

Make sure that the plastic cover is correctly closed

Do not leave the terminal box without cover: risk of damage due to contamination.

Unit installation

See the Quick Startup Guide instructions

Position the unit as shown in Figure 10

Install the unit according to the systems liquid flow.

The arrows on the pump body indicate the flow and the rotation direction

The standard rotation pump direction is clockwise (looking at the fan cover)

Always install a backflow-prevention device on the suction side.

Always install the pressure sensor on the delivery side, after the check valve.

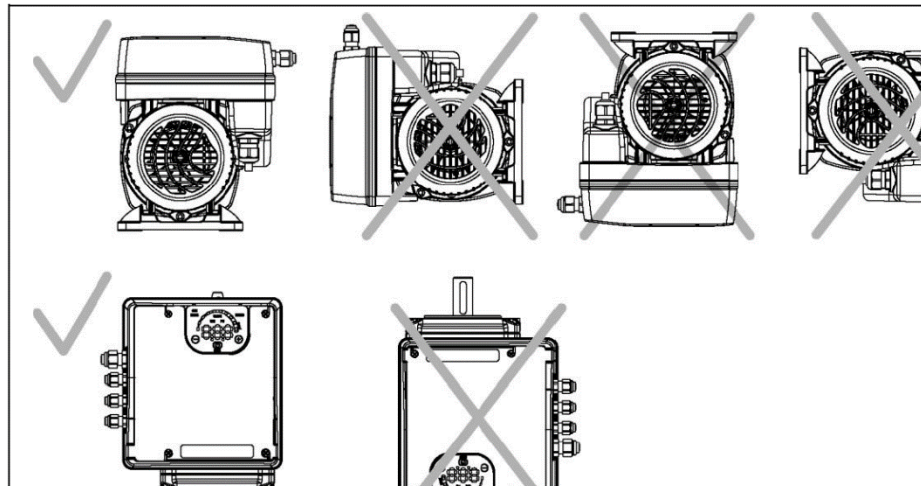

Figure 10: Permitted positions

Outdoor unit installation

In case of outdoor unit installation, ensure appropriate cover (see example in Figure 11). The size of the cover must be such that the motor is not exposed to snow, rain or direct sunlight; comply with the guidelines of Table 16.

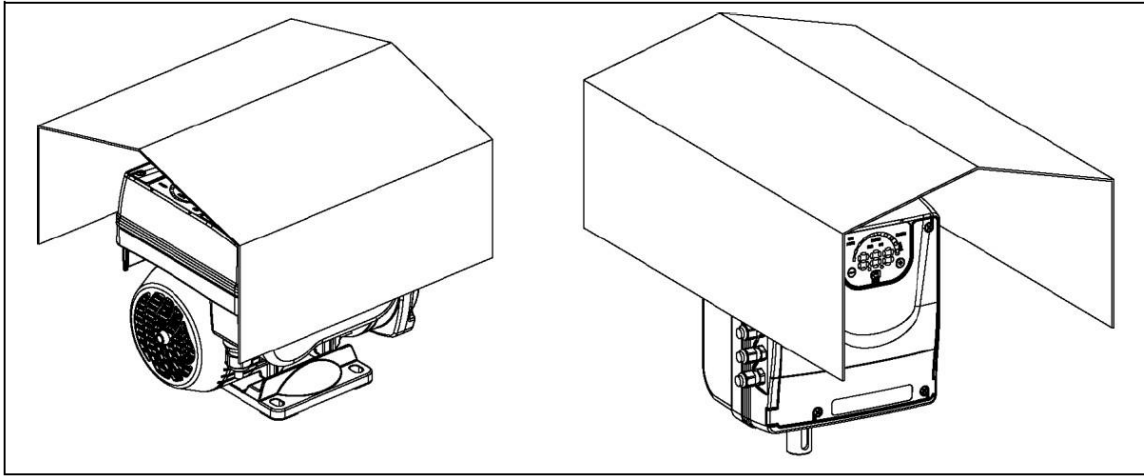

Figure 11: Outdoor installation

Minimum spacing

Area	Model	Free Distance
Above the unit	103..105..107..111..115	> 260mm (10.2 in)
Center-distance between units (to ensure space for cabling)	103..105..107..111..115	> 260mm (10.2 in)
	303..305..307..311..315..322	≥ 300mm (11.8 in)

Hydraulic installation

Figure 12 and 13 show a single pump system and a multi-pump system respectively.

NOTICE:

If the system is directly connected to the water network, install a minimum pressure switch on the suction side.

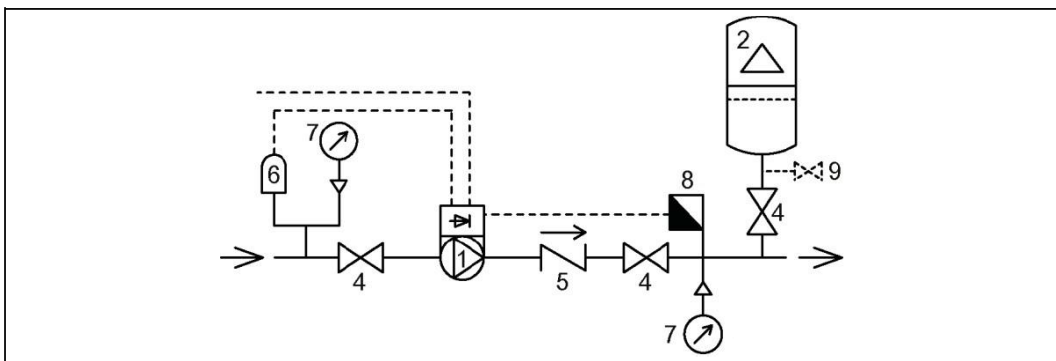

Figure 12: Single-pump system

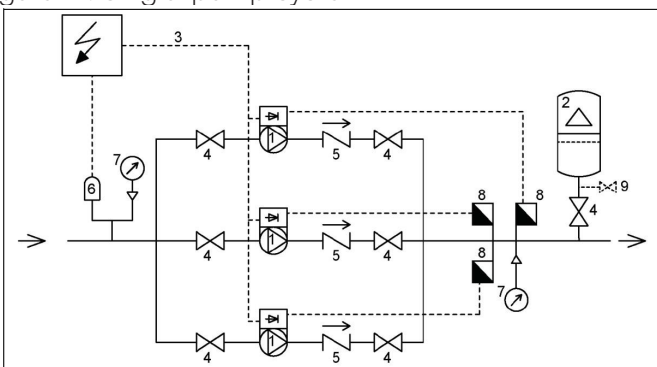

Figure 13: Multi-pump system

1. Pump with Motor Drive
2. Diaphragm pressure tank
3. Distribution panel
4. On-off valve
5. Non-return valve
6. Low water control
7. Pressure gauge
8. Pressure sensor
9. Drain tap

Pressure tank

On the pump delivery side there is a membrane expansion vessel, which gives the possibility of maintaining the pressure inside the piping when the system is not being used. The unit stops the pump from continuing to run at zero demand and reduce the size of the tank that is required for supply purposes.

Select a vessel suitable for the system pressure, and pre-load it in accordance with the values indicated in the Quick Startup Guide.

Electrical Installation

The connection to the electric power supply must be completed by an electrician possessing the technical-professional requirements outlined in the current regulations.

Electrical requirements

Local directives prevail on the specific requirements indicated below.

Electrical connection checklist

- Check that the following requirements are met:
- The electrical leads are protected from high temperature, vibrations, and collisions.
- The current type and voltage of mains connection must correspond to the specifications on the data plate on the pump.
- The power supply line is provided with:
 - A high-sensitivity differential switch (30 mA) [residual current device RCD] suitable for earth fault currents with DC or pulsating DC content (a Type B RCD is suggested).
 - A mains isolator switch with a contact gap of at least 3 mm.

The electrical control panel checklist

The control panel must match the ratings of the electric pump. Inappropriate combinations do not guarantee the protection of the unit.

Check that the following requirements are met:

- The control panel must protect the pump against short-circuit. A time lag fuse or a circuit breaker (Type C model is suggested) can be used to protect the pump.
- The pump has built in overload and thermal protection, no additional overload protection is required.
-

Electrical hazard

Before starting work on the unit, make sure that the unit and the control panel are isolated from the power supply and cannot be energized.

Grounding (earthing)

- Always connect the external protection conductor to the ground terminal before attempting to make any other electrical connections
- Connect all the electric accessories of the pump and the motor to the ground, making sure that the connections are completed correctly
- Check that the protection conductor (ground) is longer than the phase conductors; in case of accidental disconnection of the power supply conductor, the protection conductor (ground) must be the last one to detach itself from the terminal.

Use a cable with several strands to reduce electric noise.

Wire types and ratings

All cables must comply with local and national standards in terms of section and ambient temperature. Use cables with minimum heat resistance +70°C (158°F); to ensure compliance with UL (Underwriters Laboratories) regulations, all power supply connections must be completed using the following types of copper cables with minimum resistance +75°C: THW, THWN

Cables must never enter into contact with the motor body, the pump and the piping.

The wires connected to the power supply terminals and the fault signal relay (NO, C) must be separated from the others by means of reinforced insulation.

Table 4: Electric connection cables

Models	Power supply input cable + PR		Tightening Torque	
	Wire numbers x Max. copper section	Wire numbers x Max. AWG	Mains and motor cable terminals	Earth conductor
103, 105, 107, 111, 115	3 x 1.5 mm ² 3 x 0.0023 sq.in	3 x 15 AWG	Spring connectors	Spring connectors
303, 305, 307, 311, 315, 322	4 x 1.5 mm ² 4 x 0.0023 sq.in	4 x 15 AWG	0.8 Nm 7.1 lb-in	3 Nm 26.6 lb-in

Control cables

External volt free contacts must be suitable for switching < 10 VDC.

:

- Install the control cables separate from the power supply cables and the fault signal relay cable
- If the control cables are installed in parallel with the power supply cable or the fault signal relay, the distance between the cables must exceed 200 mm
- Do not intersect the power supply cables; should this be necessary, a 90° intersection angle is permitted.

Table 5: Recommended control cables

Drive control cables	Wires number x Max. copper Section	AWG	Tightening torque
All I/O conductors	0.75-1.5 mm 0.00012-0.0023 sq.in	18-16 AWG	0.6 Nm 5.4 lb-in

Power supply connection

Contact with electric components may cause death, even after the unit has been switched off. Before any interventions on the unit, the network voltage and any other input voltages must be disconnected for the minimum time indicated in Table 9.

Table 6: Power supply wiring procedure

1. Open the terminal box cover (2) by removing the screws (1).	Fig. 9
2. Insert the power cable in the M20 cable gland (5)	Fig 14
3. Connect the cable according to the wiring diagram.	Fig. 9

Table 7: I/O wiring procedure

1. Open the terminal box cover (2) by removing the screws (1).	Fig. 9
2. Connect the cable according to the wiring diagram.	Fig. 15
3. Close the cover (2) and tighten the screws (1).	Fig. 9

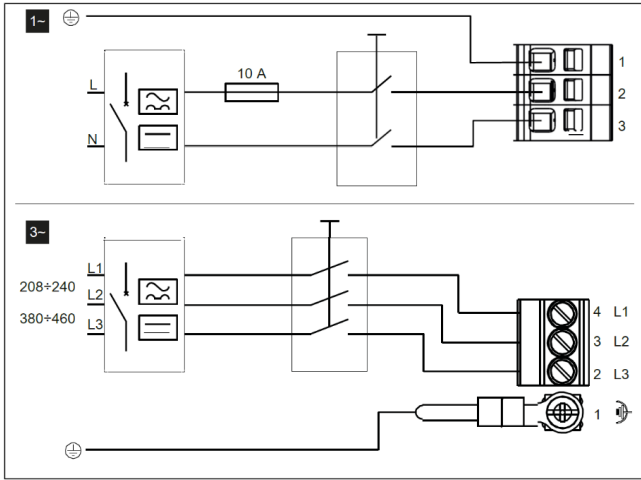

Figure 14: Wiring diagram

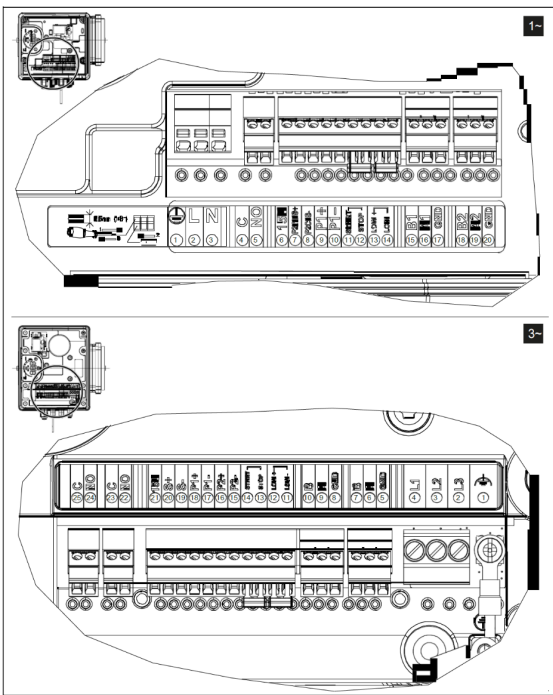

Figure 15: Connection label
Table 8: I/O terminals

1~	Item	Terminals	Ref.	Description	Notes
	Fault Signal	C	4	COM - error status relay	
		NO	5	NO - error status relay	
	Auxiliary Voltage Supply	15V	6	Auxiliary voltage supply +15 VDC	15VDC, max. 100 mA
	Analog input 0-10V	P2IN/S+	7	Actuator mode 0-10 V input	0-10 VDC
		P2C/S-	8	GND for 0-10 V input	GND, electronic ground (for S+)
	External Pressure sensor [also Differential]	P1+	9	Power supply external sensor +15 VDC	15VDC, max. 100 mA
		P1-	10	External sensor 4-20 mA input	4-20 mA
	External Start/Stop	Start	11	External ON/OFF input reference	Default short circuited Pump is enabled to RUN
		Stop	12	External ON/OFF input	
	External Lack of Water	Low +	13	Low water input	Default short circuited Lack of water detection: enabled
	Communication bus	Low -	14	Low water reference	
		B1	15	RS485 port 1: RS485-1N B (-)	ACT, HCS control mode: RS 485 port1 for external communication MSE, MSY control mode: RS 485 port 1 for multi-pump systems
		A1	16	RS485 port 1: RS485-1P A (+)	
		GND	17	Electronic GND	
		B2	18	RS485 port 2: RS485 port 2: RS485-2N B (-) active only with optional module	RS 485 port2 for external communication
		A2	19	RS485 port 2: RS485 port 2: RS485- 2P A (+) active only with optional module	
		GND	20	Electronic GND	

Item	Terminals	Ref.	Description	Notes
Fault signal	C	25	COM - error status relay	In case of power cables: use the M20 cable gland
	NO	24	NO - error status relay	
Motor running signal	C	23	Common contact	In case of power cables: use the M20 cable gland
	NO	22	Normally open contact	
Auxiliary Voltage Supply	15V	21	Auxiliary voltage supply +15 VDC	15VDC, max. 100 mA
Analog input 0-10V	S+	20	Actuator mode 0-10 V input	0-10 VDC
	S-	19	GND for 0-10 V input	GND, electronic ground (for S+)
External Pressure sensor [also Differential]	P1+	18	Power supply external sensor +15VDC	15VDC, max. 100 mA
	P1-	17	External sensor 4-20 mA input	4-20 mA
External pressure sensor	P2+	16	Power supply external sensor +15VDC	15VDC, max. 100 mA
	P2-	15	Sensor 4-20 mA input	4-20 mA
External Start/ Stop	Start	14	External ON/OFF input	Default short circuited Pump is enabled to RUN
	Stop	13	External ON/OFF input reference	
External Lack of Water	Low+	12	Low water input	Default short circuited Lack of water detection: enabled
	Low-	11	Low water reference	
Communication Bus	B2	10	RS485 port 2: RS485 port 2: RS485-2N B (-) active only with optional module	RS 485 port2 for external communication
	A2	9	RS485 port 2: RS485 port 2: RS485-2P A (+) active only with optional module	
	GND	8	Electronic GND	
	B1	7	RS485 port 1: RS485-1N B (-)	ACT, HCS control mode: RS 485 port 1 for external communication Control mode MSE, MSY: RS 485 port 1 for multi-pump systems
	A1	6	RS485 port 1: RS485-1P A (+)	
	GND	5	Electronic GND	

3~

Operation

In case of co-existence of two or more of the following conditions:

- High ambient temperature
- High water temperature
- Duty points insisting on unit maximum power
- persisting under voltage of mains, may jeopardise the life of the unit, and/or derating may occur: for further information contact Flowtech.

Wait times

Contact with electric components may cause death, even after the unit has been switched off. Before any interventions on the unit, the network voltage and any other input voltages must be disconnected for the minimum time indicated in Table 9.

Table 9: Wait times

Model	Minimum waiting time (min)
103, 105, 107, 111, 115	4
303, 305, 307, 311, 315, 322	5

Frequency converters contain DC-link capacitors that can remain charged even when the frequency converter is not powered.

To avoid electrical hazards:

- Disconnect the AC power supply
- Disconnect all types of permanent magnet motors
- Disconnect all DC-link remote power supplies, including the battery backups, the Uninterrupted Power Supply units and the DC-link connections to other frequency converters
- Wait for the capacitors to discharge completely before carrying out any maintenance or repairs; see Table 9 for the waiting times

Programming Precautions

- Carefully read and follow the following instructions before starting the programming activities, to avoid wrong settings that may cause malfunctioning
- All modifications must be done by qualified technicians.

Control panel

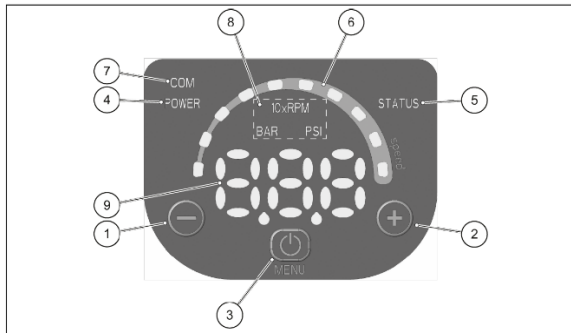







Figure 16: Control panel

Table 10: Description of the control panel

Position number	Position number
1	Decrease button
2	Increase button
3	START/STOP and menu access button
4	POWER LED
5	Status LED
6	Speed LED bar
7	Communication LED
8	Unit of measure LEDs
9	Display

Description of the buttons

Table 11: Functions of push buttons

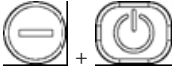
Push Button	Function
	<ul style="list-style-type: none"> Main view: decreases the required value for the selected control mode Parameter menu: decreases the displayed parameter index Parameter view / editing: decreases the value of the displayed parameter Zero pressure auto-calibration: automatic calibration of the pressure sensor.
	<ul style="list-style-type: none"> Main view: increases the required value for the selected control mode Parameter menu: increases the displayed parameter index Parameter view / editing: increases the value of the displayed parameter Zero pressure auto-calibration: automatic calibration of the pressure sensor.
	<ul style="list-style-type: none"> Main view: START/STOP the pump Parameter menu: switches to parameter view / editing Parameter view / editing: saves the value of the parameter.
 Long press	<ul style="list-style-type: none"> Main view: switches to parameter selection Parameters Menu: switches to Main Visualization
	<ul style="list-style-type: none"> Main view: alternates between Speed and Head units of measure.
	<ul style="list-style-type: none"> Main view: alternates between Speed and Head units of measure.

LEDs description

POWER (power supply)

When ON (**POWER**) the pump is powered and the electronic devices are operational.

STATUS

LED	Status
Off	Pump unit stopped
Green Steady	Pump unit in operation
Flashing green and orange	Non-locking alarm with the pump unit in operation
Orange steady	Non-locking alarm with the pump unit stopped
Red steady	Locking error, the pump unit cannot be started

SPEED (speed bar)

It consists of 10 LEDs, each representing, in percentage steps between 10 and 100%, the speed range between parameter P27 (minimum speed) and parameter P26 (maximum speed).

LED	Status
On	Motor in operation; the speed corresponds to the percentage step represented by
First LED flashing	The LEDs ON in the bar (e.g.: 3 LEDs ON = speed 30%)
ff	Motor in operation; the speed is lower than the absolute minimum, P27

COM (communication)

Condition 1

- The communication bus protocol is the Modbus RTU protocol; the P50 parameter is set to the Modbus value
- No optional communication module is used.

LED	Status
Off	The unit cannot detect any valid Modbus messages on the terminals provided for the communication bus
Green steady	The unit has detected a communication bus on the provided terminals and has recognised the correct addressing
Green flashing	The unit has detected a communication bus on the provided terminals and has not been addressed correctly
From green steady to off	The unit has not detected a valid Modbus RTU message for at least 5 seconds
From green steady to flashing	The unit has not been addressed correctly for at least 5 seconds

Condition 2

- The communication bus protocol is the BACnet MS/TP protocol; the P50 parameter is set to the BACnet value
- No optional communication module is used.

LED	Status
Off	The unit has received no valid requests from other BACnet MS/TP devices for at least 5 seconds
On Steady	The unit is exchanging information with another BACnet MS/TP device

Condition 3

- A multi-pump control mode is selected (e.g. MSE or MSY)
- No optional communication module is used.

LED	Status
Off	The unit has received no valid requests from other pumps through the multi – pump BUS for at least 5 seconds
On Steady	The unit is exchanging information with another pump through the multi-pump BUS

Condition 4

The optional communication module is being used.











LED	Status
Off	RS485 or wireless connection faulty or missing
Flashing	The unit is exchanging information with the communication module

Unit of measurement

LED on	Measurement active	Notes
10xRPM	Impeller rotation speed	The display shows the speed in 10xRPM
BAR	Hydraulic head	The display shows the value of the head in bar
PSI		The display shows the value of the head in psi

Display







Main visualization

Display	Mode	Description
OFF	OFF	Contacts 11 and 12 are not short-circuited. Note: It has lower display priority than STOP mode.
STP	STOP	Pump stopped manually. If the pump is switched on after setting P04 = OFF, it is stopped so that the motor is not in operation, and STP flashes (STP → STP). To manually stop the pump: • Example A. HCS, MES, MSY control modes with initial required value (head) of 4.20 bar and minimum value 0.5 bar: 4.20 BAR →  press → STP once. • Example B. ACT control mode with initial required value (speed) of 200 10xRPM and minimum value 80 10xRPM: 200 10xRPM →  press → STP once.
ON	ON	Pump on; the motor starts following the selected control mode. It appears for a few seconds when contacts 11 and 12 are short circuited and the pump is not in STOP mode. To manually set the pump to ON mode: • Example A. HCS, MES, MSY control modes that reach a required value (head) of 4.20 bar, starting with a minimum value of 0.5 bar after manual stop: STP →  press → ON → once after a few seconds → 4.20 BAR. • Example B. ACT control mode that reaches a requested value (speed) of 200 10xRPM, starting with a minimum value of 80 10xRPM after manual stop: STP →  press → ON → once, and after a few seconds → 200 10xRPM. With the pump in operation, it is possible to display the Actual Head and the Actual Speed: • Example A HCS, MES, MSY control modes with Actual Head 4.20 bar and corresponding Actual Speed of 352 10xRPM: 4.20 BAR →  +  352 10xRPM → after 10 seconds or  +  → 4.20 BAR Example B ACT control mode with Actual Speed 200 10xRPM and corresponding Actual Head of 2.37 bar: 200 10xRPM  +  2.37 BAR → after 10 seconds or + → 200 10xRPM.

Parameters menu visualization

The parameter menu gives the possibility to:

- Select all the parameters.
- Access Parameter View / Editing.



Parameter	Description
Power On	If after switching ON, parameter Menu View is accessed with P23 = ON, P20 flashes: Enter the password to display and change the parameters.
Password timeout	If with P23 = ON no button is pressed for over 10 minutes from the last parameter Menu View, both the view and the editing of the parameters are disabled. Enter the password again to display and change the parameters.
Parameters Menu	With P23 = OFF, or after entering the password (P20), it is possible to both display and edit the parameters. When accessing the Parameter Menu, the display shows: P01 → P01 P02 → P02 ... P69 → P69 The flashing parameter, indicating the selection possibility.
Parameters Editing/ Visualization	The value of a parameter may be changed using the buttons, or the Modbus and BACnet communication protocols. When returning to the Parameter Menu, the displayed parameter index is increased automatically. • Example A (P20) from 000 to 066: P20 → P20 →  000 → 000 →  ... until ... → 066 → 066 →  sets the desired value → P21 → P21 • Example 2 (P26) from 360 to 300: P26 → P26 →  360 → 360 →  until → 300 → 300 →  sets the desired value → → P26 → P26

Alarms and errors visualization









Parameter	Description
Alarm	In case of alarm, the corresponding code appears on the display in alternation to the Main View. For example: A01 → 3.56 (ex. BAR) A02 → 285 (ex. 10xRPM)
Error	In case of error, the corresponding identification code appears on the display. For example: E01, E02





Software parameters

Parameters are marked differently in the manual depending on their type:

Mark	Parameter type
No mark	Applicable to all units
	Global parameter, shared by all pumps in the same multi -pump system
	Read only

Status Parameters





No.	Parameter	Unit of measurement	Description
P01	Required value	bar/psi/	This parameter shows the SOURCE and the VALUE of the active required value. Visualization cycles between SOURCE and VALUE occur every 3 seconds. SOURCES: • SP (SP): internal required value Setpoint related to the control mode selected. • VL (UL): external required value speed Setpoint related to 0 -10V input. VALUE can represent a Speed or a Head, depending on the selected control mode: In case of Head, the unit of measure is defined by parameter P41.
P02	Effective Required Value	bar/psi	Active required value calculated based on parameters P58 and P59. This parameter is effective only in control modes MSE or MSY. For further information on the calculation of P02.
P03	Regulation Restart Value [0-100] 	%	It defines the start value after the stop of the pump, as a percentage of the P01 value. If the required value is met and there is no further consumption, then the pump stops. The pump starts again when the pressure drops below P03. P03 is valid when: • Different from 100% (100%=off) • The control mode is HCS, MSE or MSY. Default:100%.
P04	Auto-start [OFF- ON] 		If P04 = ON, then the pump starts automatically following a power supply disconnection. If the pump is switched on after setting P04 = OFF), it is stopped so that the motor is not in operation, and STP flashes (STP → STP). Default: ON.
P05	Operating time months 		Total months of connection to the electric mains, to add to P06.
P06	Operating time hours 	h	Total hours of connection to the electric mains, to add to P05.
P07	Motor Time Months 		This parameter shows the total operating time months, to be added to P08
P08	Motor time hours 	h	This parameter shows the total operating time hours, to be added to
P09	1st error		This parameter stores the last error occurred in chronological order. The information displayed switches through the values: • (Exx): xx indicates the error code • (Hyy): yy is the value of hours referred to P05-P06 when the error Exx happened • (Dww): ww is the value of days referred to P05-P06 when the error Exx happened • (Uzz): zz is the value of weeks referred to P05-P06 when the error Exx happened Example of visualization E04 → K10 → d03 → U15
P10	2nd error 		Saves the penultimate error in chronological occurred. Other characteristics: like P09.
P11	3rd error 		Saves the third from the last error in chronological occurred. Other characteristics: like P09.
P12	4th error 		Saves the fourth from the last error in chronological occurred. Other characteristics: like P09.











P13	Power Module Temperature 	°C	Temperature of the power module.
P14	Inverter Current 	A	This parameter shows the actual current supplied by the frequency converter.
P15	Inverter Voltage 	V	This parameter shows the actual estimated input voltage of the frequency converter.
P16	Motor Speed 	rpmx10	This parameter shows the actual motor rotational speed.
P17	Software version 	A	This parameter shows the Control Board software version.

Settings Parameters







No.	Parameter	Description
P20	Password entering [0-999]	The user can enter here the system password, which gives access to all system parameters: this value is compared with the one stored in P22. When a correct password is entered, the system remains unlocked for 10 minutes.
P21	Jog mode [MIN-MAX*]	It deactivates the internal controller of the unit and forces the actual Control Mode (ACT): the motor starts and the value of P21 becomes the temporary ACT setpoint. It can be changed by just entering a new value on P21 without confirming it; otherwise, it causes immediate exit from temporary control.
P22	System password [1-999]	This is the system password, and must be the same as the password entered in P20. Default: 66.
P23	Lock Function [OFF, ON]	By using this function, the user can lock or unlock parameter setting in the main menu. When ON, enter the P20 password to change the parameters. Default: ON.

Drive Configuration Parameters

No.	Parameter	Unit of measurement	Description
P25	Control mode [ACT, HCS, MSE, MSY]		This parameter sets the Control Mode (default value: HCS)
			<p>ACT: Actuator mode.</p> <p>A single pump maintains a fixed speed at any flow rate. ACT will always try to minimize the difference between the speed setpoint and the actual rotational speed of the motor.</p> <p>If a 0-10V signal is supplied to terminals 7 and 8, the pump automatically switches to ACT mode, following the external signal, as shown in figure 17.</p> <p>If the external signal is missing, the pump remains in ACT mode, using the value set as setpoint using the display.</p>
			<p>HCS: Controller mode for Single pump.</p> <p>The pump maintains a constant pressure at any flow rate: the algorithm, based on the set of parameters from P26 to P37, is implemented.</p> <p>HCS mode must be set in conjunction with the use of an absolute reading pressure sensor installed in the hydraulic circuit, which supplies to the unit the pressure feedback signal: HCS will always try to minimize the difference between the pressure setpoint and the pressure feedback signal.</p>
			<p>MSE: Controller mode for multiple pumps in Serial Cascade. Pumps are managed in series: only the last activated pump modulates the speed to maintain the set pressure, while all the others in operation rotate at the maximum speed.</p> <p>The set of pumps, connected to each other through the multi-pump protocol, maintains a constant pressure at any flow rate: the algorithm, based on the set of parameters from P26 to P37, is implemented.</p> <p>MSE mode must be set in conjunction with the use of absolute reading pressure sensors, one for each pump, which supply to the set the pressure feedback signal: MSE will always try to minimize the difference between the pressure setpoint and the pressure feedback signal. Using the multi-pump protocol, it is possible to connect up to 3 pumps, all of the same type and with the same power.</p>
			<p>MSY: Controller mode for Multiple pumps in Synchronous Cascade. The pumps are synchronised: they all keep the set pressure and operate at the same speed. Other characteristics: as for MSE mode.</p>
P26	Max RPM set [ACT set-Max*] 	rpmx10	Maximum pump speed setup.
P27	Min RPM set [Min*-ACT set] 	rpmx10	Minimum pump speed setup.
P28	Ramp 1 [1-250] 	s	This parameter adjusts the fast acceleration time. It affects the control of the pump for HCS, MSE and MSY control modes. Default: 3 s.
P29	Ramp 2 [1-250] 	s	This parameter adjusts the fast deceleration time. It affects the control of the pump for HCS, MSE and MSY control modes. Default: 3 s.

P30	Ramp 3 [1-999] 	s	This parameter adjusts the slow acceleration. It determines: <ul style="list-style-type: none"> • The adjustment speed, in case of small flow rate variations • The constant outgoing pressure. The ramp depends on the system being controlled, and affects the control of the pump in HCS, MSE and MSY modes. Default: 35 s.
P31	Ramp 4 [1-999] 	s	Adjustment of the slow deceleration time. Other characteristics: as for Ramp 3.
P32	Ramp Speed Min Acceleration [2.0-25.0] 	s	This parameter sets the fast acceleration time. It represents the acceleration ramp used by the controller until the minimum speed of the pump is reached (P27). It affects the control of the pump for HCS, MSE and MSY control modes. Default: 2.0 s.
P33	Ramp Speed Min Deceleration [2.0-25.0] 	s	This parameter sets the fast deceleration time. It represents the deceleration ramp used by the controller for stopping the pump once the minimum speed of the pump is reached (P27). It affects the control of the pump for HCS, MSE and MSY control modes. Default: 2.0 s.
P34	Speed Min Configuration [STP, SMI] 		This parameter defines the operation of the controller once the minimum speed of the pump is reached (P27): <ul style="list-style-type: none"> • STP (STP): once the required pressure is reached and no further request is made, the pump speed decreases to the selected P27 value: then keeps running for the selected time interval (P35), and then stops automatically. • SNI (SMI): once the required pressure is reached and no further request is made, the pump speed decreases to the selected P27 value: continues running at the same speed. This parameter affects the control of the pump for HCS, MSE and MSY control modes. Default: STP
P35	Smin time [0-100] 	s	This parameter sets the time delay before a shut-off below P27 occurs. It is only used by the controller if P34 = STP. It affects the control of the pump for HCS, MSE and MSY control modes. Default: 0 s.
P36	Window [0-100] 	%	This parameter sets the ramp control interval, as a percentage of the pressure setpoint. It is used to define the range of pressures, around the setpoint, in which the controller uses slow acceleration and deceleration ramps instead of fast ones. It affects the control of the pump for HCS, MSE and MSY control modes. Default: 10%.
P37	Hysteresis [0-100] 	%	This parameter sets the slow ramp hysteresis, as a percentage of P36. It helps define the pressure range, around the setpoint, in which the controller goes from slow acceleration ramp (P28) to slow deceleration ramp (P29). The parameter affects the control of the pump for HCS, MSE and MSY control modes. Default: 80%.
P38	Speed Lift [0-MAX*] 	rpmx10	This parameter sets the speed limit after which the linear increase of the actual require value starts (P02), until the total increase (P39) at maximum speed (P26). Default: P27.
P39	Lift Amount [0-200] 	%	This parameter sets the increase value of the actual required value (P02) at the maximum speed (P26), measured as a percentage of the required value (P01). It determines the increase of the required pressure set, useful to compensate for flow resistances at high flow rates. Default: 0.

Sensor Configuration Parameters





No.	Parameter	Unit of measurement	Description
P41	Pressure Sensor Unit Of Measure [BAR, PSI]		This parameter sets the unit of measure (BAR, PSI) for the pressure sensor. It affect the head view LED parameter. Default: bar.
P42	Full scale value for pressure Sensor 1 4-20mA [0.0-25.0BAR] / [0.0-363PSI] 	bar/psi	This parameter sets the Full Scale value of the 4-20mA pressure sensor connected to analog input 17 and 18. Default: depending on the type of pump.
P44	Zero Pressure Auto-Calibration	bar/psi	This parameter lets the user perform the initial auto-calibration of the pressure sensor. It is used to compensate for the offset signal of the sensor at zero pressure caused by the tolerance of the sensor itself. Procedure: 1. Access P44 when the hydraulic system is at 0 pressure (no water inside), or with the pressure sensor disconnected from the piping; the actual value of 0 pressure is displayed. 2. Start the auto-calibration by pressing  or  . 3. At the end of the auto-calibration, the 0 (zero) pressure is displayed, or the “---“ (---) message, if the sensor signal is out of the permitted tolerance.
P45	Pressure Minimum Threshold [0-42] 	bar/psi	Setting the minimum pressure threshold. If the system pressure falls below this threshold for the time set in P46, a low pressure error E14 is generated. Default: 0 bar.
P46	Pressure Minimum Threshold - Delay Time [1-100] 	s	Time delay setup. This parameter sets the time delay during which the unit remains idle with a system pressure below P45, before generating the low pressure error E14. Default: 2 s.
P47	Pressure Minimum Threshold – Automatic Error Reset [OFF, ON] 		Enabling/disabling of automatic unit attempts in case of low pressure error. Default: ON.
P48	Lack Of Water Switch Input [DIS, ALR, ERR] 		This parameter enables/disables the management of the lack of input water, terminals 13 and 14). It defines the behavior of the unit when the lack of water input is enabled and the switch is open: • (DIS): the unit doesn't manage the information coming from the “lack of water” input • (ALr): the unit reads the “lack of water” Input (enabled) and reacts, at the opening of the switch, by displaying the corresponding alarm A06 on the display, and keeping the motor running • (Err): Err, the unit reads the Lack Of Water Input (enabled) and reacts, at the opening of the switch, by stopping the motor and generating the corresponding error E11. The error condition is removed when the switch closes again and the motor is started. Default: ERR.

RS485 Interface Parameters

No.	Parameter	Unit of measurement	Description
P50	Communication protocol [MOD, BAC]		This parameter selects the specific protocol on the communication port: <ul style="list-style-type: none"> • NOD (MOD): Modbus RTU • BAC (BAC): BACnet MS/TP. Default: MOD.
P51	Communication protocol - Address [1-247]/[0-127]		This parameter sets the desired address for the unit, when connected to an external device, depending on the protocol selected in P50: <ul style="list-style-type: none"> • MOD: any value in the 1-247 range • BAC: any value in the 0-127 range.
P52	Comm Protocol – BAUDRATE [4.8, 9.6, 14.4, 19.2, 38.4, 56.0, 57.6 KBPS]	kbps	This parameter sets the desired baud rate for the communication port. Default: 9.6 kbps.
P53	BACnet Device ID Offset [0-999]		This parameter sets the hundreds, tens and units of the BACnet Device ID. Default: 002. Device ID default: 84002.
P54	Comm Protocol – Configuration 8N1, 8N2, 8E1, 8o1		This parameter sets the length of the data bits, the parity and the length of the STOP bits.

Multi-pump configuration parameters

All these parameters affect MSE and MSY control modes.

No.	Parameter	Unit of measurement	Description
P55	Multipump – Address [1-3]		This parameter sets the address of each pump based on the following criteria: <ul style="list-style-type: none"> • Each pump needs an individual pump address (1-3) • Each address may only be used once. Default: 1.
P56	Multipump – Max Units [1-3] 		This parameter sets the maximum number of pumps operating at the same time. Default: 3.
P57	Multipump – Switch Interval [0-250] 	h	Setpoint of the main pump forced switch interval. If the pump with priority 1 works in continuous mode until this time is reached, the switch between this pump and the next is forced. If on the other hand, the system stops completely due to the setpoint being reached, with the next start priority 1 will be assigned in a way to ensure an even distribution of the operating hours of all pumps. Default: 24 h.
P58	Multipump – Actual Value Increase [0.0-25.0BAR] / [0.0-363PSI] 	bar/psi	This parameter affects the calculation of P02, to improve the Multipump control. Default: 0.35 bar.
P59	Multipump – Actual Value Decrease [0.0-25.0BAR] / [0.0-363PSI] 	bar/psi	This parameter affects the calculation of P02, to improve the multi - pump control. Default: 0.15 bar.
P60	Multipump – Enable Speed [P27-P26] 	rpmx10	This parameter sets the speed that a pump must reach before starting the next assist pump, after a system pressure drop below the difference between P02 and P59. Default: depending on the type of pump.

P61	Multipump Synchronous – Speed Limit [P27-P26] G	rpmx10	This parameter sets the speed limit below which the first assist pump stops. Default: depending on the type of pump.
P62	Multipump Synchronous – Window [0-100] G	rpmx10	This parameter sets the speed limit for the stop of the next assist pump. Default: 150 rpmx10.
P63	Multipump – Priority G		This parameter shows the pump priority value within the multi-pump set. This parameter displays the following information: (Pr1) .. (Pr3) or (Pr0) where: <ul style="list-style-type: none"> • Pr1 .. PR3, indicate that the pump is communicating with others pumps and its priority order, is equal to the visualized number. • Pr0 indicates that the pump does not detect the communication with other pumps and is considered alone in the multi-pump bus
P64	Multipump – Revision G	rpmx10	This parameter shows the multi-pump protocol revision value used.

Test Run Configuration Parameters

Test Run is a function that starts the pump after the last stop, in order to prevent it from blocking.

No.	Parameter	Unit of measurement	Description
P68	Default Values Reload [NO,rE]		If set to RES, after confirmation this parameter performs a factory reset that reloads the default parameter values.
P69	Avoid Frequent Parameters Saving [NO, YES]		This parameter limits the frequency with which the unit stores the required value P02 in the EEPROM memory, in order to extend its life. This could be particularly useful in applications with BMS control devices that require continuous variation of the value for fine tuning purposes. Default: NO.

Technical references

Example: ACT control mode with analog 0-10V input
Graph

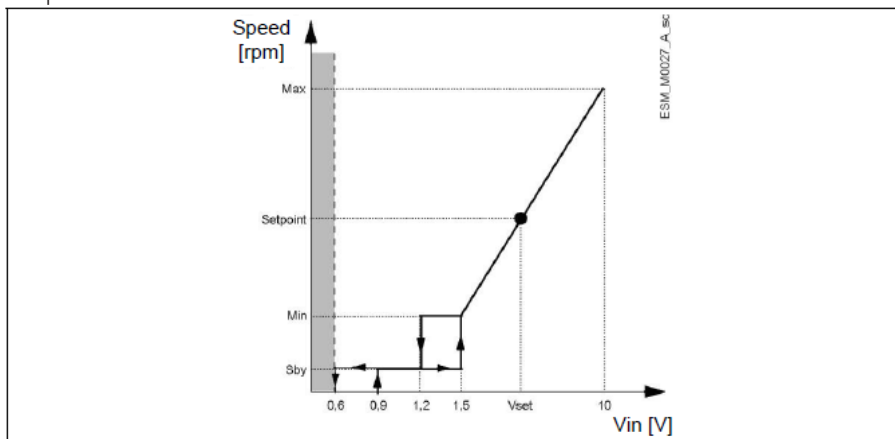

Figure 17: ACT control mode diagram

Table 12: Description

Grey area	Missing input Voltage detection threshold
-----------	---

Speed [rpm]	Actual speed relative to the 0-10V analogue input voltage value (see Par. 4.3.3, table 8 contacts 7 and 8)
Max	P26 (Max RPM set)
Min	P27 (Min RPM set)
Setpoint	Example of Actual Speed related to a specific Vset Voltage value
Sby	Input Voltage at which the motor goes in Stand By
Vin [V]	Input Voltage value to control the pump in ACT mode Different thresholds are managed by the pump, from Non-detection to Max speed)

Example: Ramp Settings

Graph

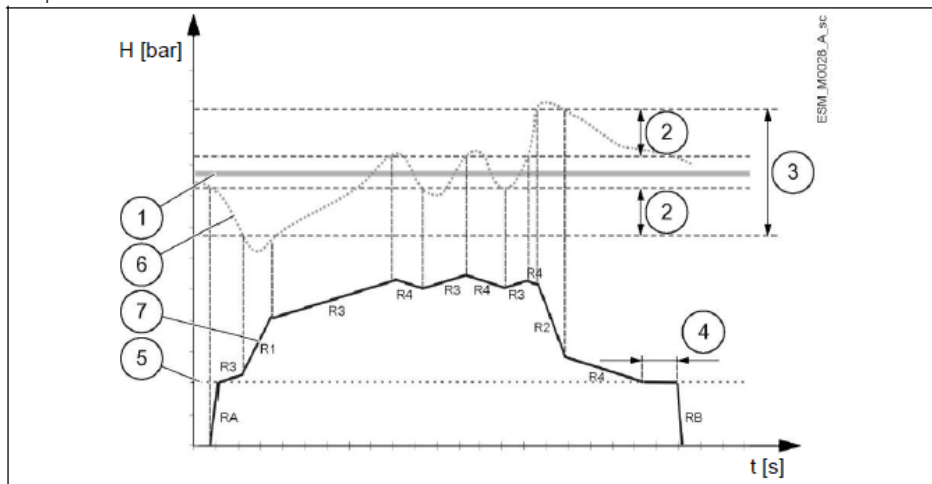

Figure 18: Ramp settings

Table 13: Description

1	P01 (Required Value)
2	P37 (Adjustment hysteresis) as a % of P36 (Adjustment window)
3	P36 (Adjustment window) as a % of P01 (Required Value)
4	P35 (Minimum speed - Duration)
5	P27 (Minimum speed)
6	Actual Head
7	Actual Speed
RA	P32 (Acceleration ramp at startup)
RB	P32 (Deceleration ramp at shutdown)
R1	P28 (Ramp 1) - Fast ramp speed increase
R2	P29 (Ramp 2) - Fast ramp speed decrease
R3	P30 (Ramp 3) - Slow ramp speed increase
R4	P31 (Ramp 4) - Slow ramp speed decrease

Example: Effective Required Value

Pumps activation in cascade modes:

1. Lead pump reaches its P60 (Enable Speed).
2. Actual value falls to the cut in-value of the 1st assist pump.

The 1st assist pump switches on automatically. (Cut-in value = P01 (Required Value) - P59 (Actual Value Decrease))

3. A new required value, P02 (Effective Required Value) is calculated after the start up.

Calculation of Effective Required Value in Cascade Serial (MSE):

K = number of active pumps

Pr = pump priority

$P02 \text{ (Actual Required Value)} = P01 \text{ (Required Value)} + (K - 1) * P58 \text{ (Actual Value Increase)} - (Pr - 1) * P59 \text{ (Actual Value Decrease)}$

Calculation of Effective Required Value in Cascade Synchronous (MSY):

K = number of active pumps ($K \geq Pr$)

$P02 \text{ (Actual Required Value)} = P01 \text{ (Required Value)} + (K - 1) * (P58 - P59)$

Behaviour of P58 (Actual Value Increase) and P59 (Actual Value Decrease):

- if $P58 \text{ (Actual Value Increase)} = P59 \text{ (Actual Value Decrease)}$ → Pressure constant, independent of how many pumps are in operation.
- if $P58 \text{ (Actual Value Increase)} > P59 \text{ (Actual Value Decrease)}$ → Pressure rises when assist pump switches on.
- if $P58 \text{ (Actual Value Increase)} < P59 \text{ (Actual Value Decrease)}$ → Pressure decreases when assist pump switches on.

Maintenance

- Before attempting to use the unit, check that it is unplugged and that the pump and the control panel cannot restart, even unintentionally. This also applies to the auxiliary control circuit of the pump.
 - Before any interventions on the unit, the network power supply and any other input voltages must be disconnected for the minimum time indicated in Table 9 (the capacitors of the intermediate circuit must be discharged by the built-in discharge resistors).
1. Make sure that the cooling fan and the vents are free from dust.
 2. Make sure that the ambient temperature is correct according to the limits of the unit.
 3. Make sure that qualified personal perform all modifications of the unit.
 4. Make sure that the unit is disconnected from the power supply before any work is carried out.
- Always consider the pump and motor Instruction.

Function and parameter control

In case of changes to the hydraulic system:

1. Make sure that all functions and parameters are correct
2. Adjust the functions and parameters if necessary.

Troubleshooting

In case of alarm or error, the display shows and ID code and the STATUS LED turns on.

In case of several alarms and/or errors, the display shows the main one.

Alarms and errors:

- are saved with date and time
- can be reset by switching the unit off for at least 1 minute.

Errors cause the triggering of the status relay on the following terminal box pins:

- Single-phase version: pins 4 and 5
- Three-phase version: pins 24 and 25

Alarm codes

Table 14: Alarm codes

Code	Description	Cause	Remedy
A03	Derating	Temperature too high	Lower the room temperature Lower the water temperature Lower the load
A05	Data memory alarm	Data memory corrupted	1. Reset the default parameters using parameter P68 2. Wait 10 s 3. Restart the pump If the problem continues, contact Flowtech
A06	LOW alarm	Lack of water detection (if P48=ALR)	Check the water level inside the tank
A15	EEPROM write failure	Data memory damaged	Stop the pump for 5 minutes and then restart it again; if the problem continues, contact Flowtech
A20	Internal alarm		Stop the pump for 5 minutes and then restart it again; if the problem continues, contact Flowtech
A30	Multi-pump connection alarm	Corrupted multi-pump connection	<ul style="list-style-type: none"> • Check the condition of the connection cables • Check that there are no address discrepancies
A31	Loss of multi-pump connection	Loss of multi-pump connection	Check the condition of the connection cables

Error codes

Code	Description	Cause	Remedy
E01	Internal communication error	Internal communication lost	Stop the pump for 5 minutes and then restart it again; if the problem continues, contact Flowtech
E02	Motor overload error	High motor current Current absorbed by the motor too high	Stop the pump for 5 minutes and then restart it again; if the problem continues, contact Flowtech
E03	DC-bus overvoltage error	DC-bus overvoltage External conditions cause the operation of the pump from generator	Check: the system configuration the position and integrity of the non-return valves
E04	Rotor blocked	Motor stall Loss of rotor synchronism or rotor blocked by external materials	Check that there are no foreign bodies preventing the pump from turning Stop the pump for 5 minutes and then start it again If the problem continues, contact Flowtech
E05	EEPROM Data memory error	EEPROM Data memory corrupted	Stop the pump for 5 minutes and then restart it again; if the problem continues, contact Flowtech
E06	Grid voltage error	Voltage supply out of operating range	Check: the voltage the connection of the electric system
E07	Motor winding temperature error	Motor thermal protection trip	Check for impurities near the impeller and rotor. Remove them if necessary Check the conditions of installation and the water and air temperature Wait for the motor to cool down If the error persists, stop the pump for 5 minutes and then start it again If the problem continues, contact Flowtech
E08	Power module temperature error	Frequency converter thermal protection trip	Check the conditions of installation, and the air temperature
E09	Generic hardware error	Hardware error	Stop the pump for 5 minutes and then restart it again; if the problem continues, contact Flowtech
E11	LOW error	Lack of water detection (if P48=ERR)	Check the water level inside the tank
E12	Pressure sensor error	Missing pressure sensor (not present in ACT mode)	Check the condition of the sensor connection cables
E14	Low pressure error	Pressure below minimum threshold (not present in ACT mode)	Check the settings of parameters P45 and P46
E15	Loss of phase error	One of the three power supply phases is missing (three-phase versions only)	Check the connection to the power supply network
E30	Multi-pump protocol error	Incompatible multi-pump protocol	Bring all the units to the same firmware version

Technical Data

Table 16: Electrical, Environmental and Installation specifications

Drive Model												
	103	105	107	111	115	303	305	307	311	315	322	
Input												
Input Frequency (hz)	50/60 ± 2											
Main Supply	LN					L1 L2						
Nominal input voltage [V]	208-240 ±10%					208-240 / 380-460 ±10%				380-460 ±10%		
Maximum current absorbed (AC) in continuous service (S1)	See data plate											
PDS Efficiency Class	IES2											
Output												
Min.-Max. Speed [rpm]	800-3600											
Leakage Current [mA]	< 3,5											
I/O auxiliary + 15VDC power supply [mA]	I _{max} < 40											
Fault signal relay	1 x NO V _{max} < 250 [VAC] , I _{max} < 2 [A]					1 x NO V _{max} < 250 [VAC] , I _{max} < 2 [A]						
Motor status relay						1 x NO V _{max} < 250 [VAC] , I _{max} < 2 [A]						
EMC (Electro Magnetic Compatibility)	See Par. Declarations. Installations must be performed in accordance with the EMC good practice guidelines (e.g. avoid “eyebolts” on the transmission side)											
Sound pressure LpA [dB(A)] @ [rpm]	< 62 @3000 < 66 @3600											
Insulation class	155 F											
Protection class	IP 55, Enclosure Type 1 Protect the product from direct sunlight and rainfall											
Relative humidity (storage)	5%-95% UR											
Storage temperature [°C]	-25-65 / -13-149											
Operating temperature [°C] / [°F]	-20-50 / -4-122											
Air Pollution	Pollution Degree 2											
Installation altitude a.s.l. [m] / [ft]	< 1000 / 3280 Derating may occur at higher altitudes											

Dimensions and weights

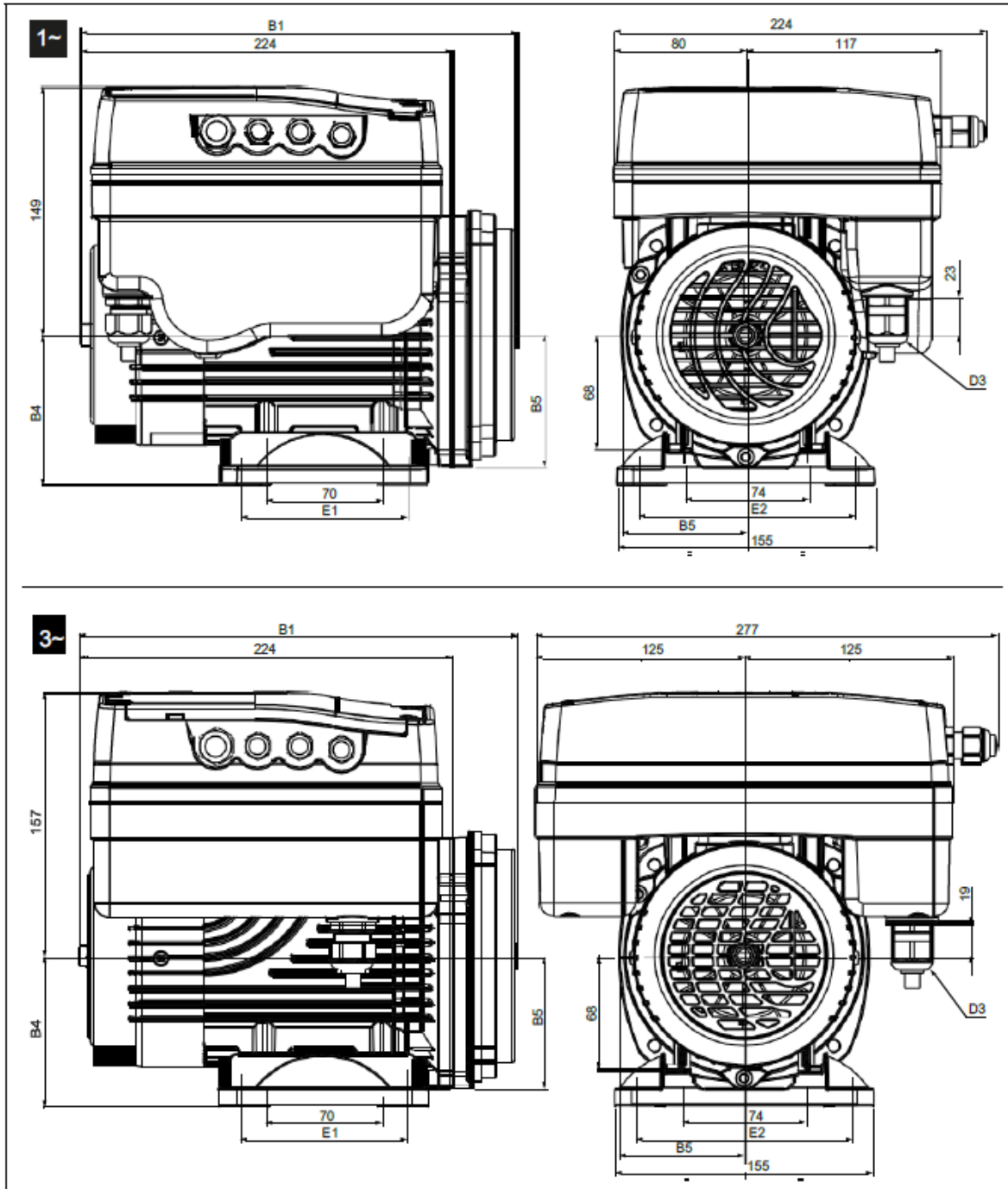

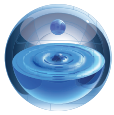

flowtech[®]
WATER SOLUTIONS

flowzone[®]

MEMBERS AREA

This section of the **flowtech**[®] website holds information exclusively for members. Members will need to log in to gain access to these pages.

Our member's will be granted exclusive access to our technical resource library. Within this resource is a wide range of product information including data sheets, technical drawings, O&M Manuals and training videos



flowcare[®]

AFTER SALES SERVICE

At **flowtech**[®] we operate a network of Service Engineers located throughout the UK who are supported by our offices located in and Greater Manchester. The distribution of engineers means that in the majority of cases we are less than 4 hours away from attending a customer call out.

We place great emphasis on providing technical back up to support our Service Engineers in resolving some difficult operational and technical issues. We pride ourselves on completing a project on time, within budget and never leaving a problem unresolved, or a customer waiting. This quality of service has made us the first choice for our customers.

FOR FURTHER INFORMATION OR ASSISTANCE

contact us

Flowtech Water Solutions are experts in water services and water booster sets. We have continuously supplied a wide range of standard and custom products since being founded in 1996.

MANUFACTURE & SUPPLY

TELEPHONE : 0333 200 1756

EMAIL: info@flowtech.org.uk

SERVICE & MAINTENANCE

TELEPHONE : 0333 200 1813

EMAIL: service@flowtech.org.uk

WEBSITE: www.flowtech.org.uk

ADDRESS : Unit 1 Lock Flight Buildings, Wheatlea Industrial Estate,
Wigan, Greater Manchester WN3 6XP United Kingdom



Membership No. 700106

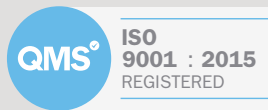

Certificate No. 185352020